

Art. Nr. 1912396
1/10

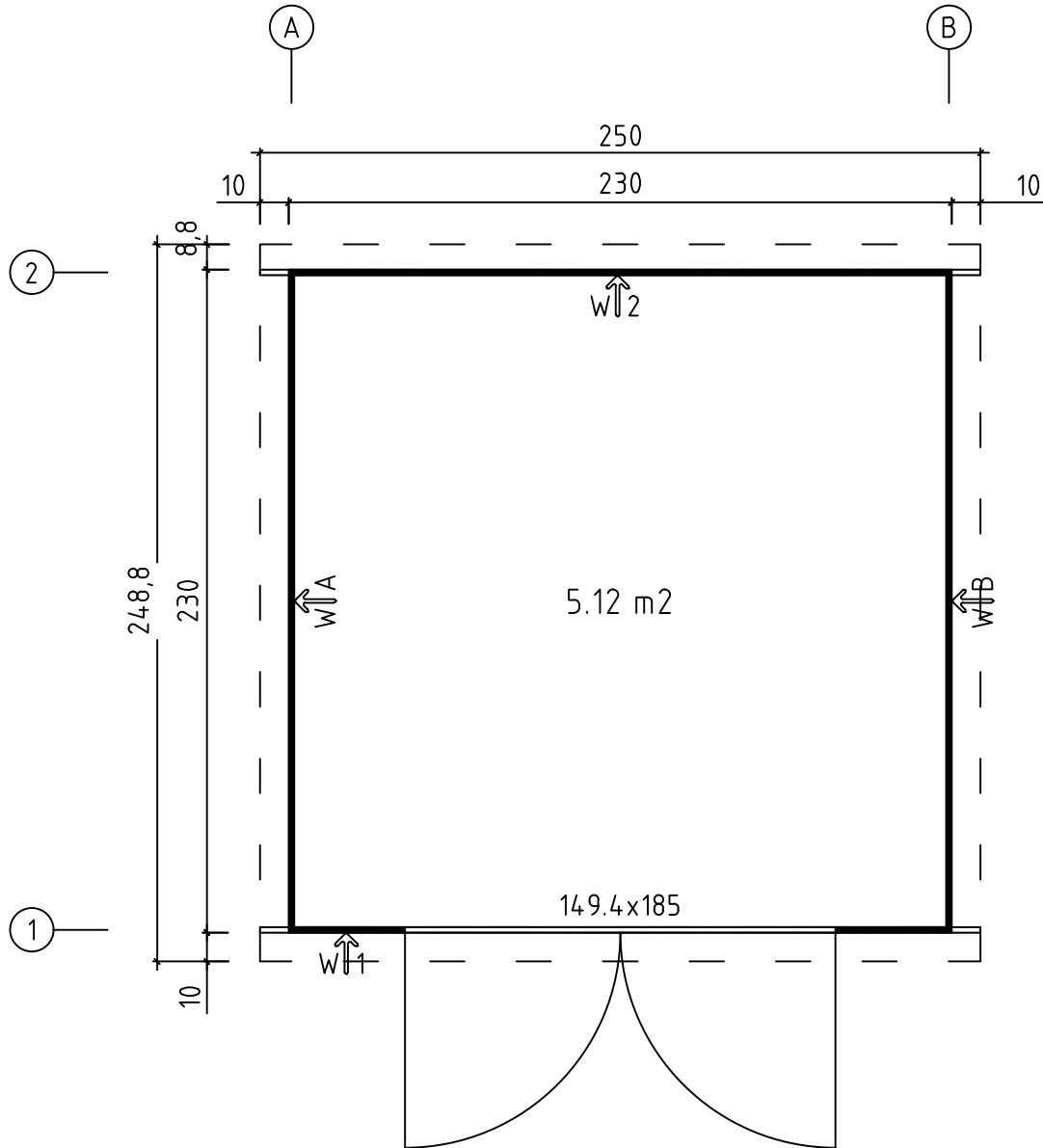

03.02.2026







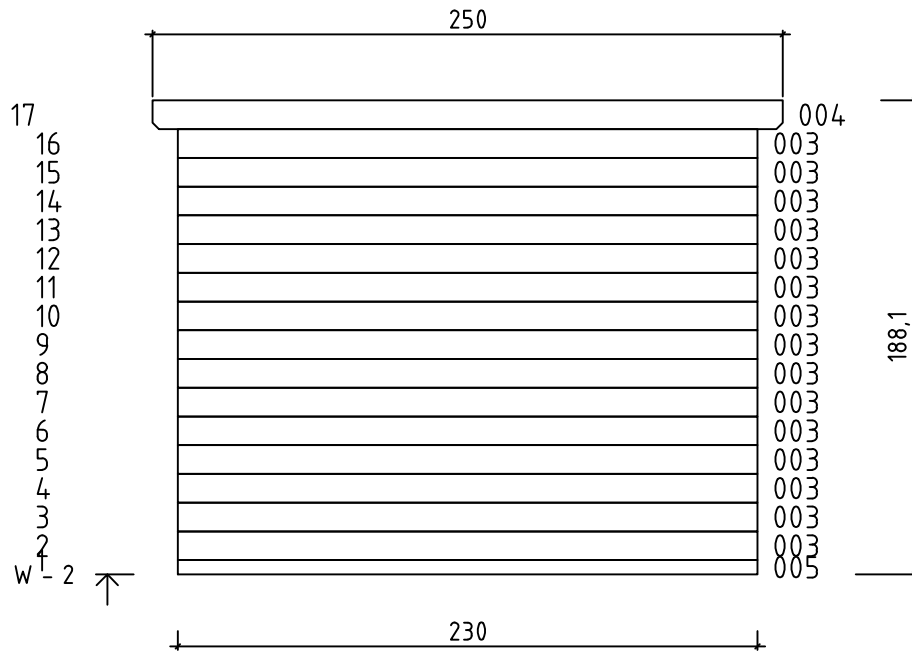
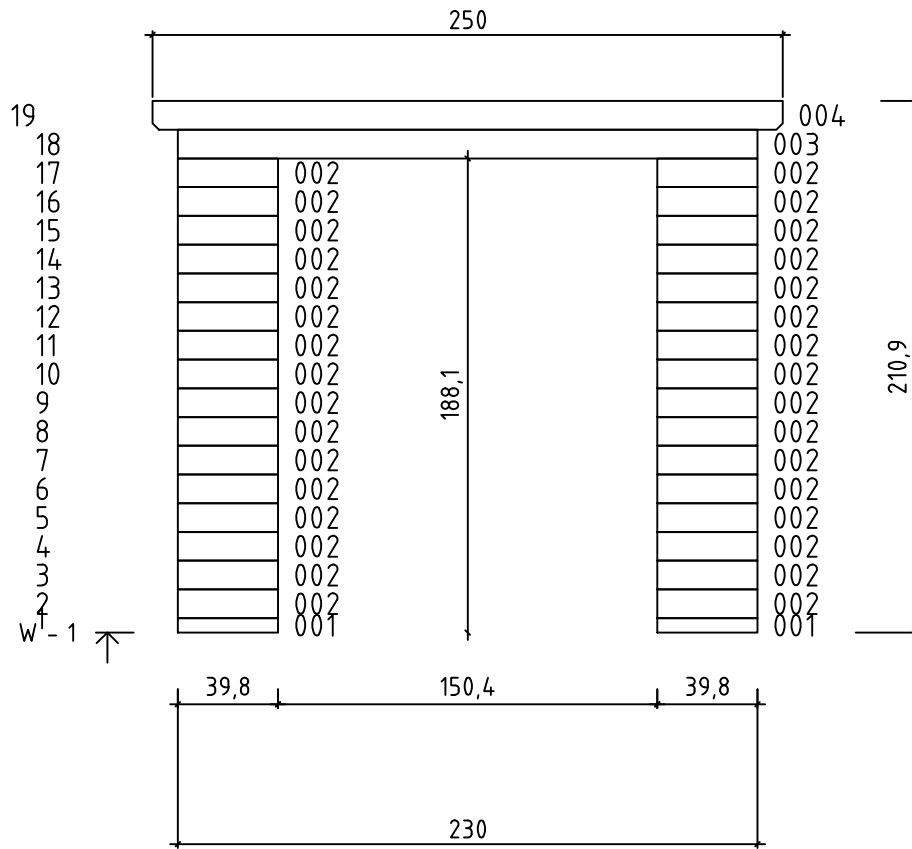

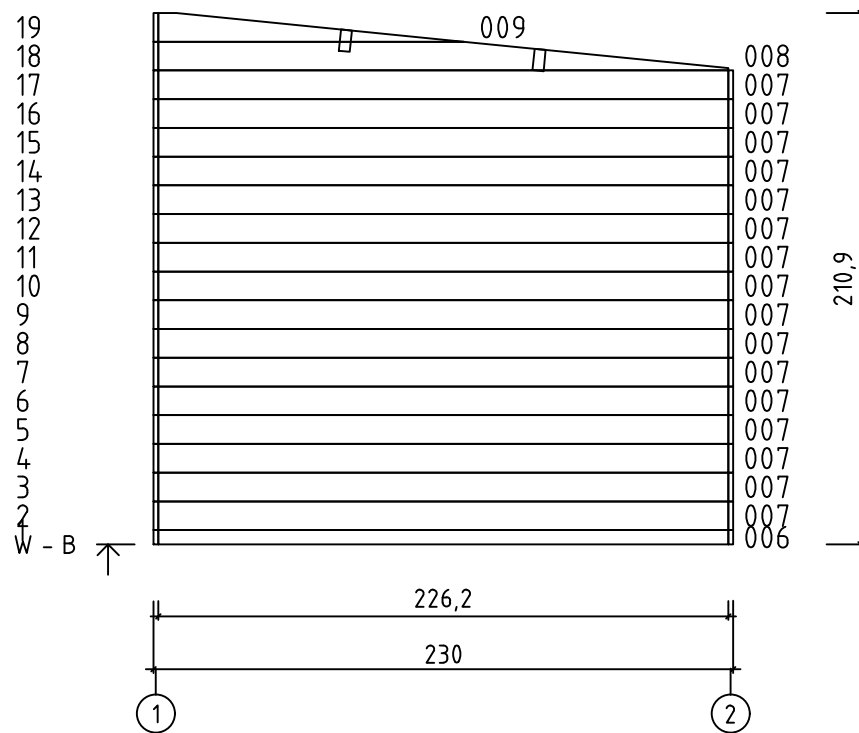
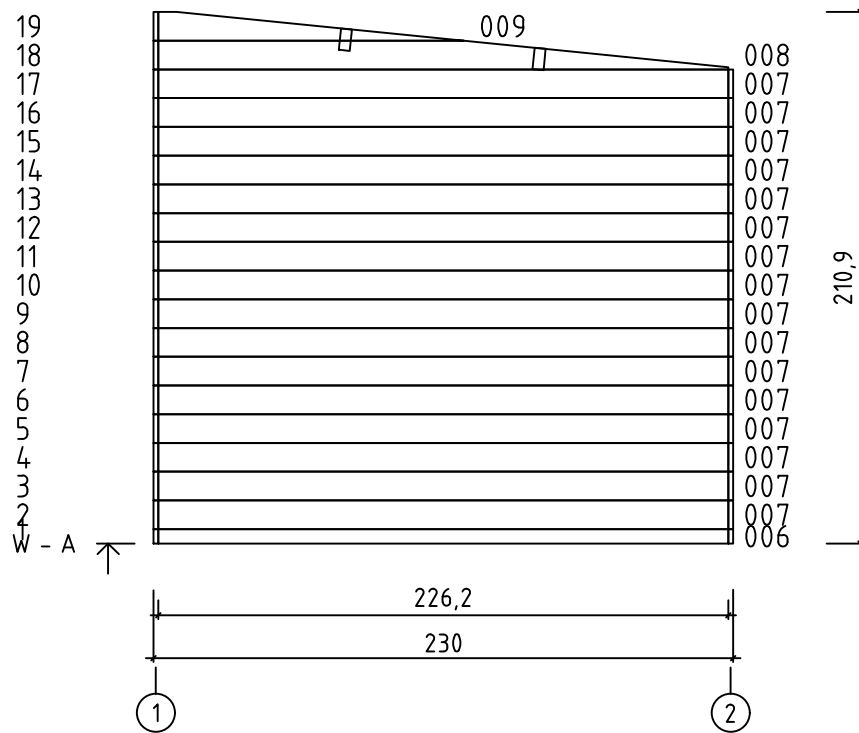
Groundplan - Grundplan - Plan de masse - Planimetria -
Plattegrond - Põhiplaan

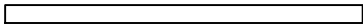

Art. Nr. 1912396

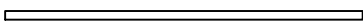
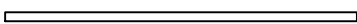
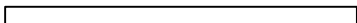
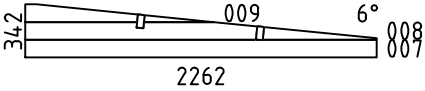
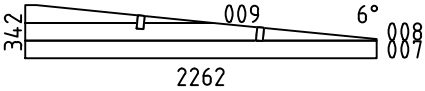
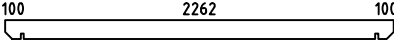
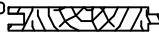

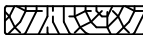
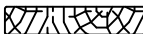
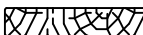
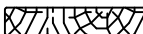

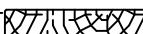
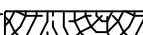
| Pos | Piece list - Stückliste - Liste des pièces - Elementi - Stuklijst - Elementos - 03.02.2026 Tükítábel Art. Nr. 1912396 | 5/10 | Q | P (mm) | L (mm) |
|-----------------|---------------------------------------------------------------------------------------------------------------------------------------------------------------------------------------------------------------------------------------------------------------------------------------------|------|----|-----------|-----------|
| 001 52713 |  | | 2 | 19x57 | 398 |
| 002 52712 |  | | 32 | 19x114 | 398 |
| 003 31541 |  | | 16 | 19x114 | 2300 |
| 004 52715 |  | | 2 | 19x114 | 2500 |
| 005 52721 |  | | 1 | 19x57 | 2300 |
| 006 52722 |  | | 2 | 19x57 | 2262 |
| 007 52716 |  | | 30 | 19x114 | 2262 |
| WA-1 52726 |  | | 1 | | |
| WB-1 52726 |  | | 1 | | |
| A-PR1 52728 | Roof beam - Dachbalken - Panne de toit - Perlina del tetto - Gordingen / dakbalk - Correa - Pärilin  | | 2 | 44x120 | 2500 |
| RB-1 34628 | Roof boards - Dachbretter - Voliges - Perlina per tetto - Dakhout - Tablero de tejado - Katuselaud  | | 28 | 90x15.5 | 2500 |
| DPL-1 52729 | Roofing felt fillet - Dachpappenleiste - Baguette de fixation du feutre bitumeux - Asse per fissaggio guaina bituminosa - Afdeklijst asfaltpapier - Moldura de fieltro para tejado - Katusepapiiliist  | | 2 | 15x45 | 2520 |
| DPL-2 34484 | Roofing felt fillet - Dachpappenleiste - Baguette de fixation du feutre bitumeux - Asse per fissaggio guaina bituminosa - Afdeklijst asfaltpapier - Moldura de fieltro para tejado - Katusepapiiliist  | | 1 | 15x45 | 2530 |
| TBE7-1 39886 | Corner fillet - Deckleiste - Profils de finition angles a l'exterieur - Massello d'angolo - (hoek)lijst - Moldura de esquina - Nurgaliist  | | 2 | 15x70 | 1767 |
| TBE7-2 23516 | Corner fillet - Deckleiste - Profils de finition angles a l'exterieur - Massello d'angolo - (hoek)lijst - Moldura de esquina - Nurgaliist  | | 2 | 15x70 | 1881 |
| TBE7-3 39988 | Corner fillet - Deckleiste - Profils de finition angles a l'exterieur - Massello d'angolo - (hoek)lijst - Moldura de esquina - Nurgaliist  | | 2 | 15x70 | 1995 |
| TBE7-4 23517 | Corner fillet - Deckleiste - Profils de finition angles a l'exterieur - Massello d'angolo - (hoek)lijst - Moldura de esquina - Nurgaliist  | | 2 | 15x70 | 2109 |
| P2-1 47670 | Post - Pfosten - Poteau - Piede registrabile - Stijl - Poste - Post  | | 2 | 44x44 | 1870 |
| P2-2 42239 | Post - Pfosten - Poteau - Piede registrabile - Stijl - Poste - Post  | | 2 | 44x44 | 2100 |
| TB3-1 34486 | Fascia board - Traufbrett - Bandeau de toit - Finitura lati tetto - Gevellijst - Tablero de alero - Räästalaud  | | 1 | 15x120 | 2530 |
| TB3-2 52488 | Fascia board - Traufbrett - Bandeau de toit - Finitura lati tetto - Gevellijst - Tablero de alero - Räästalaud  | | 2 | 15x120 | 2550 |

Art. Nr. 1912396

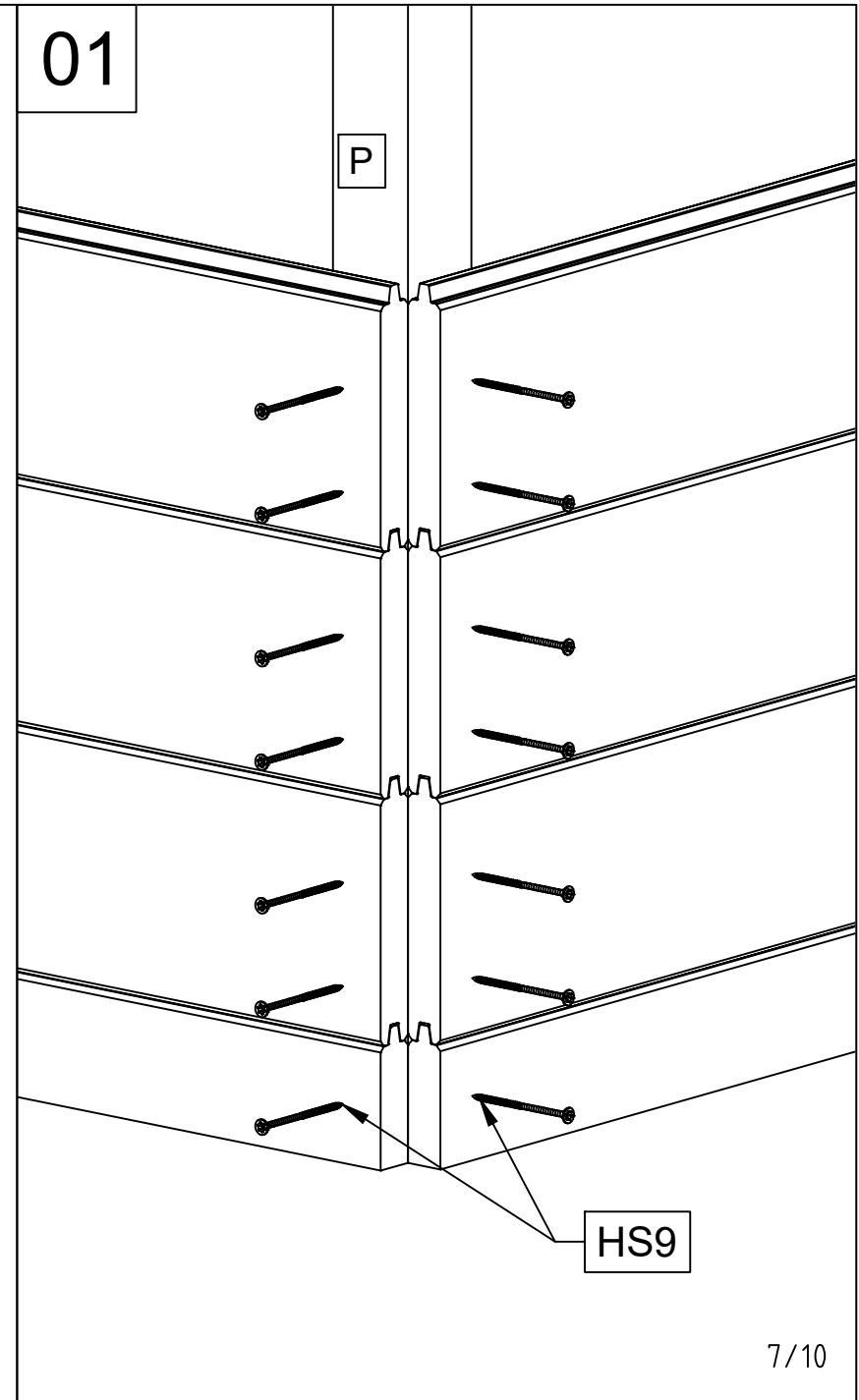
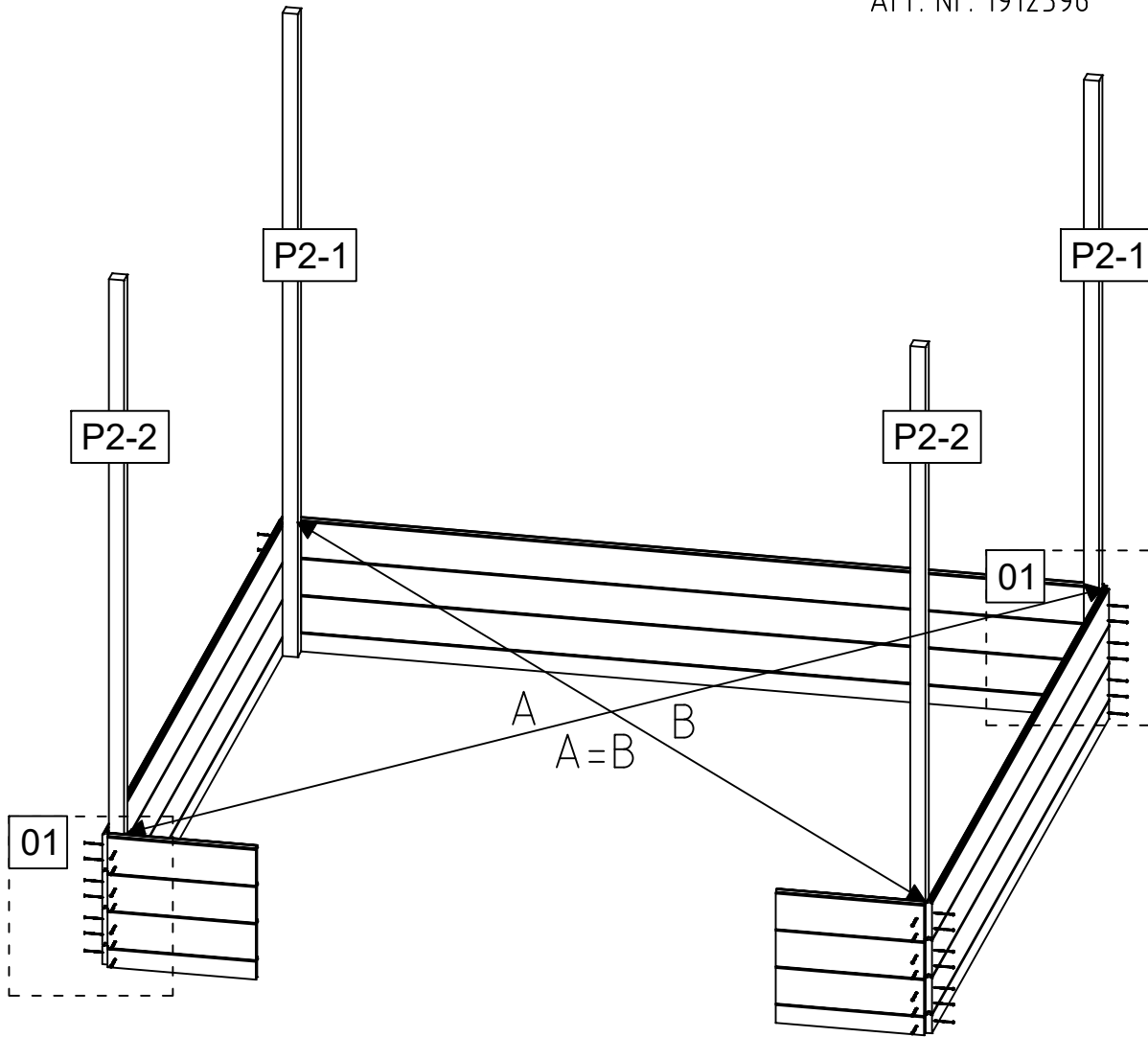

Art. Nr. 1912396

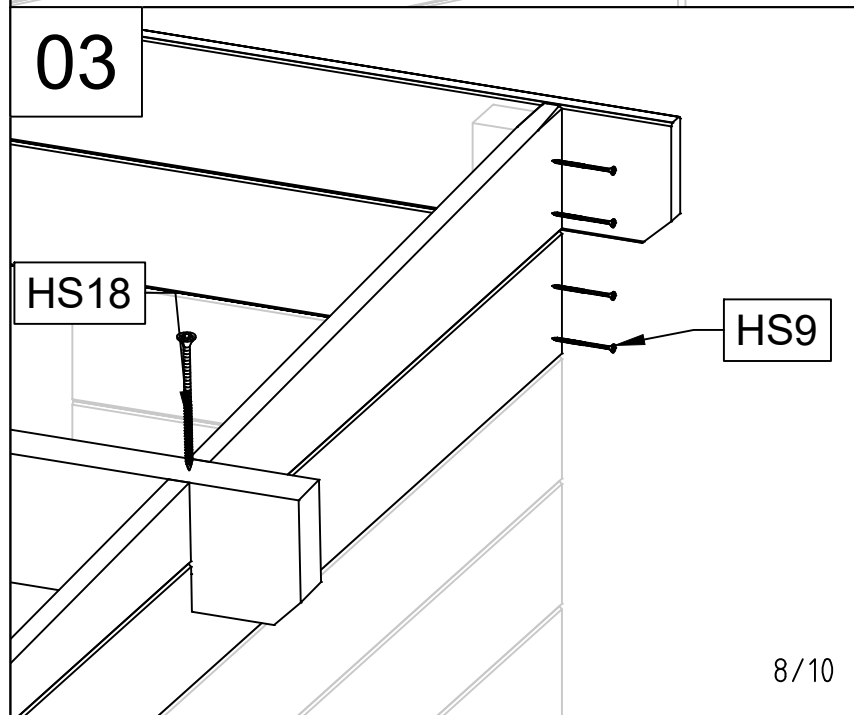
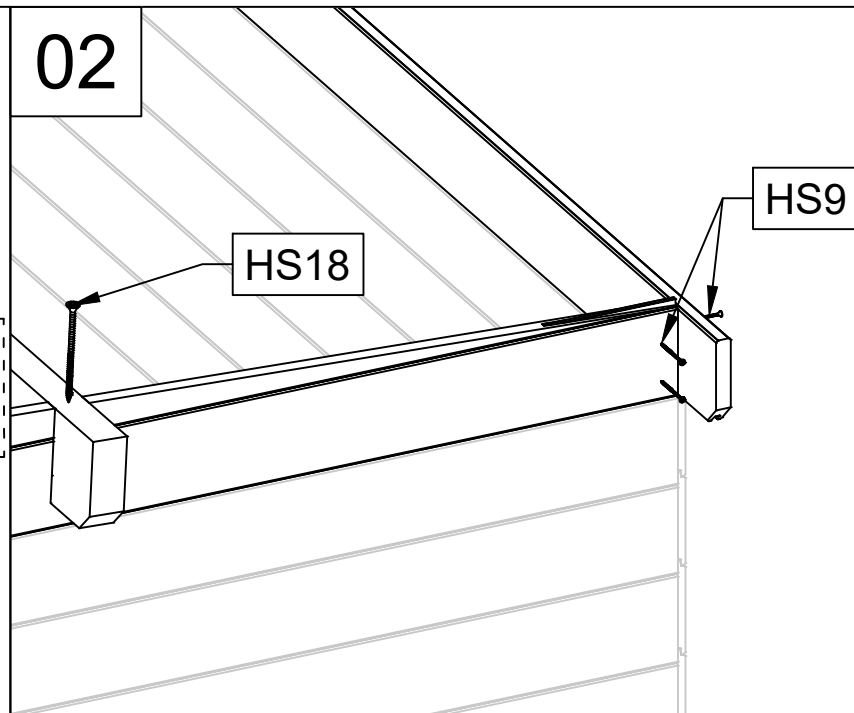
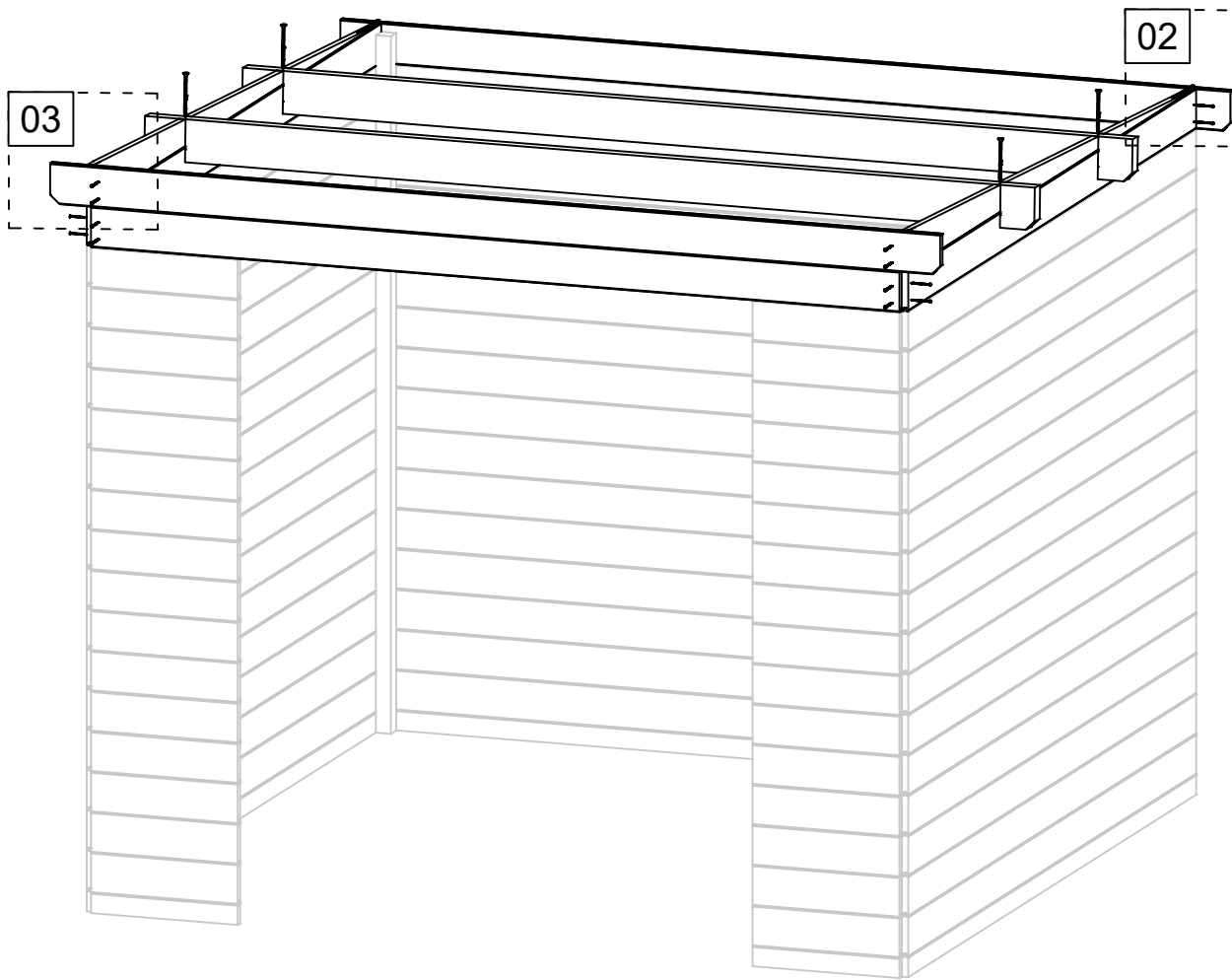



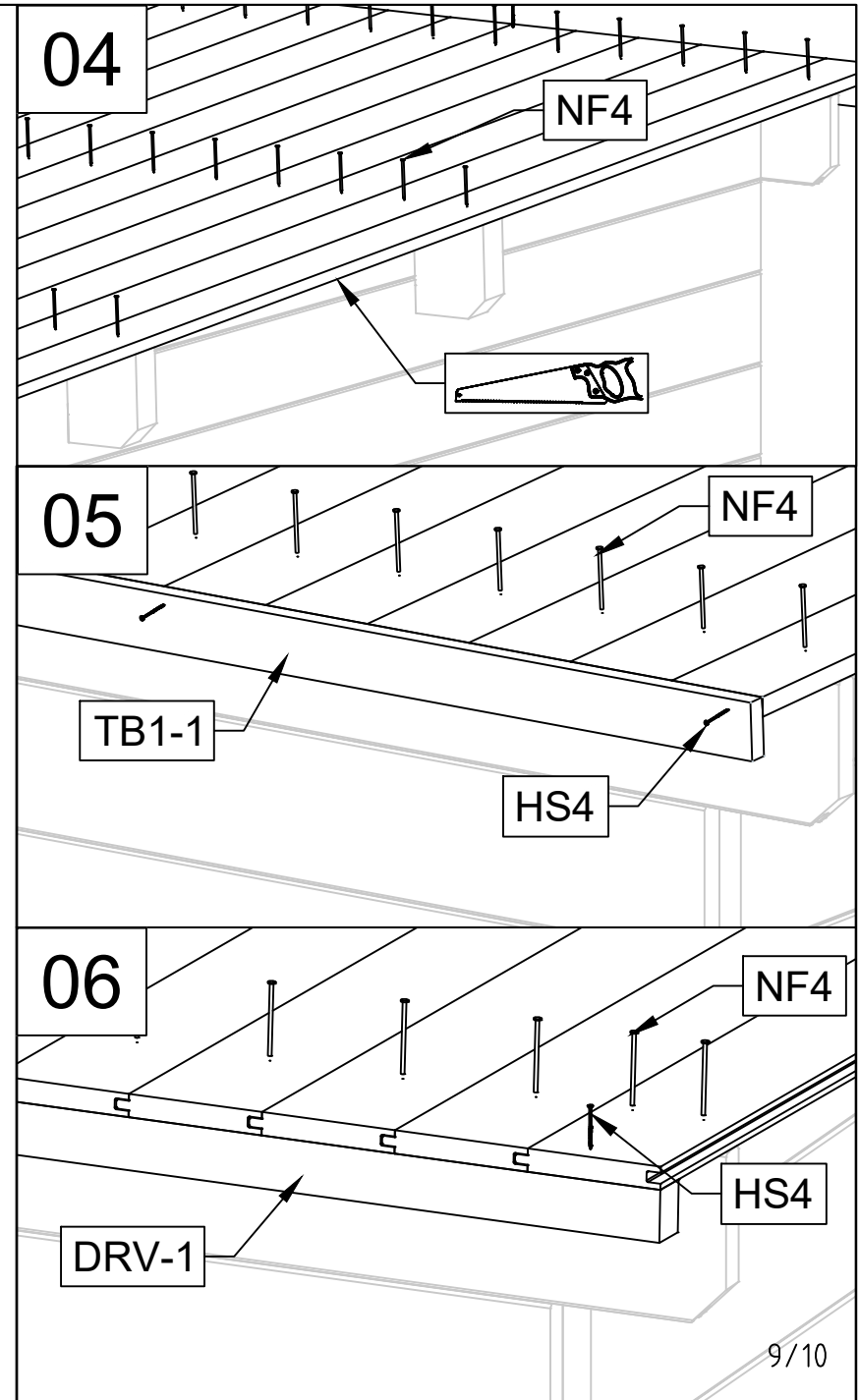
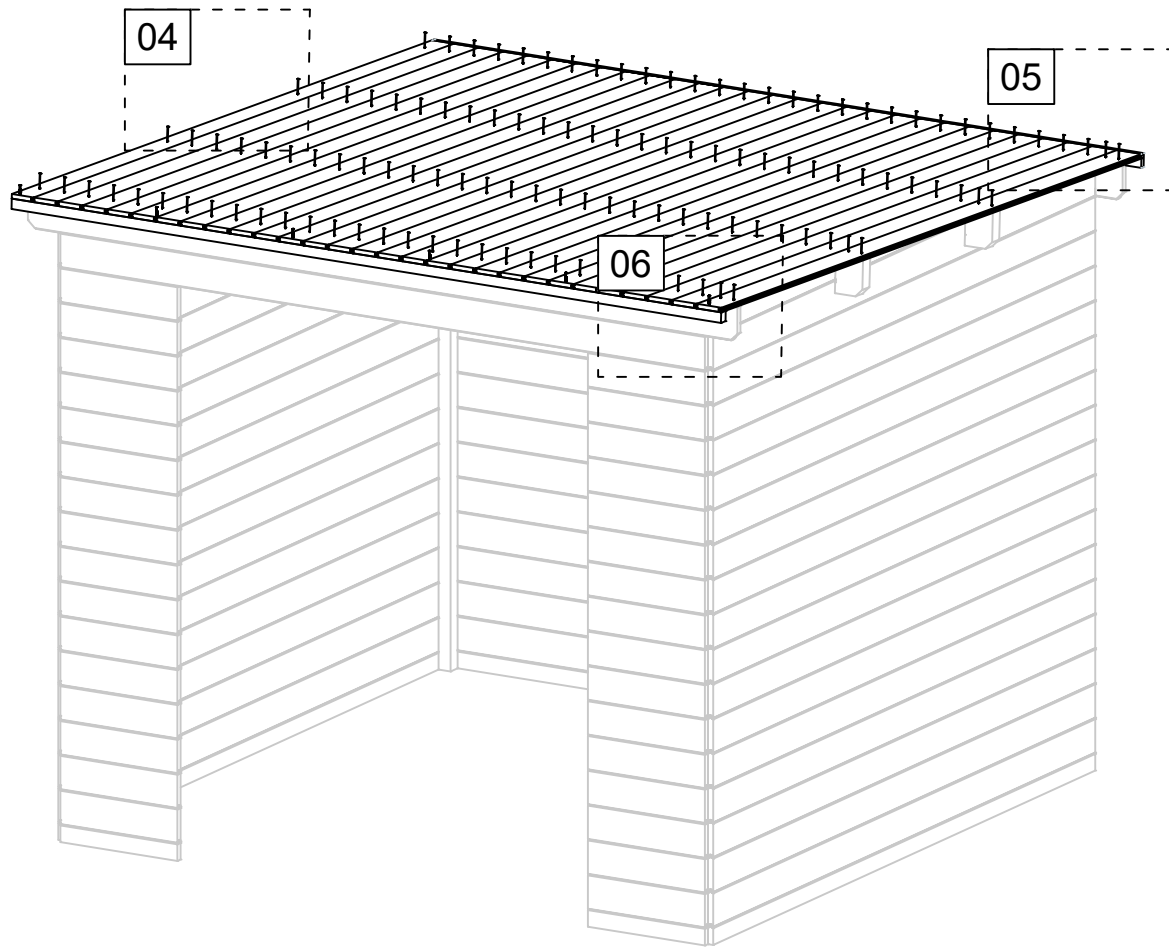



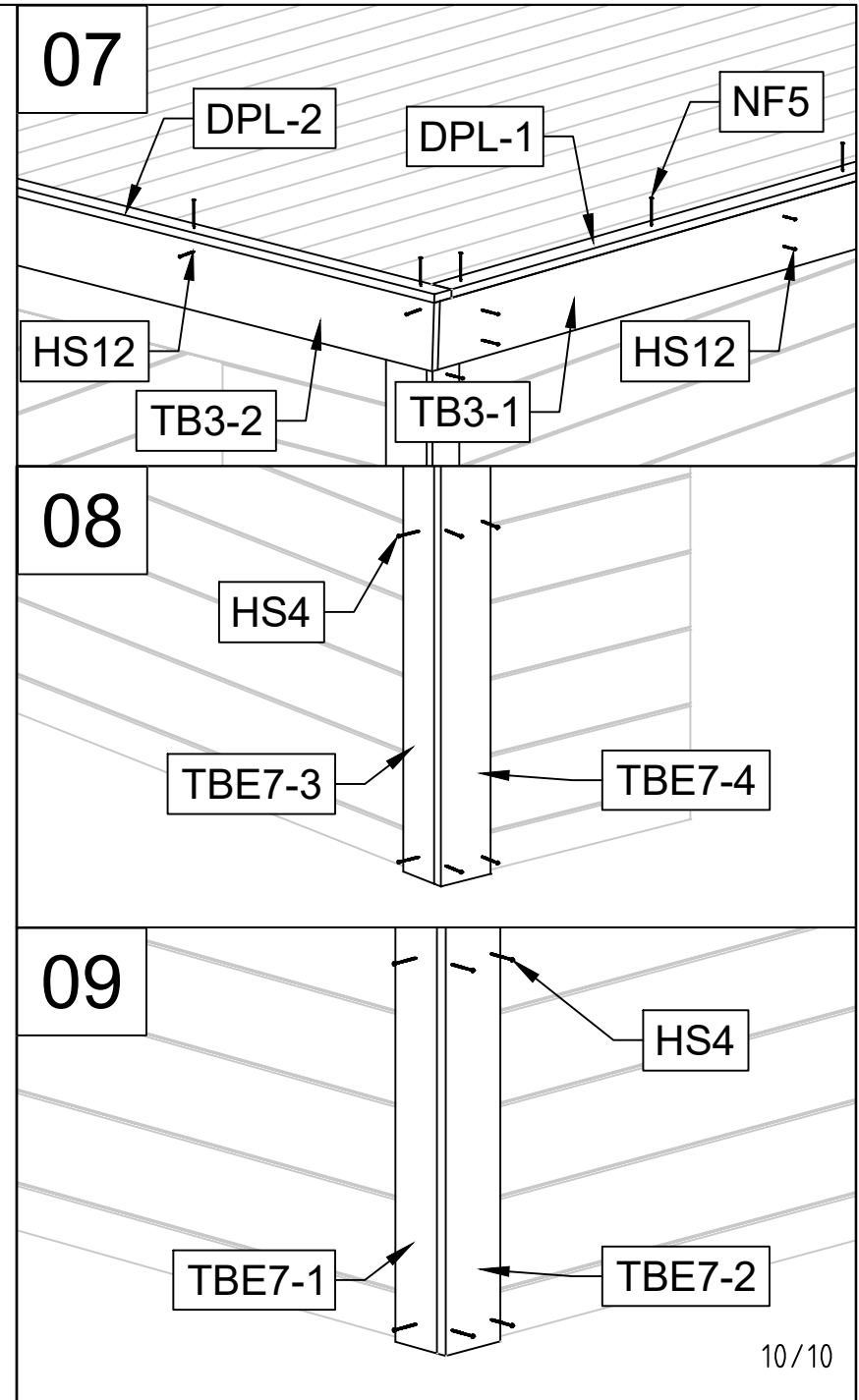
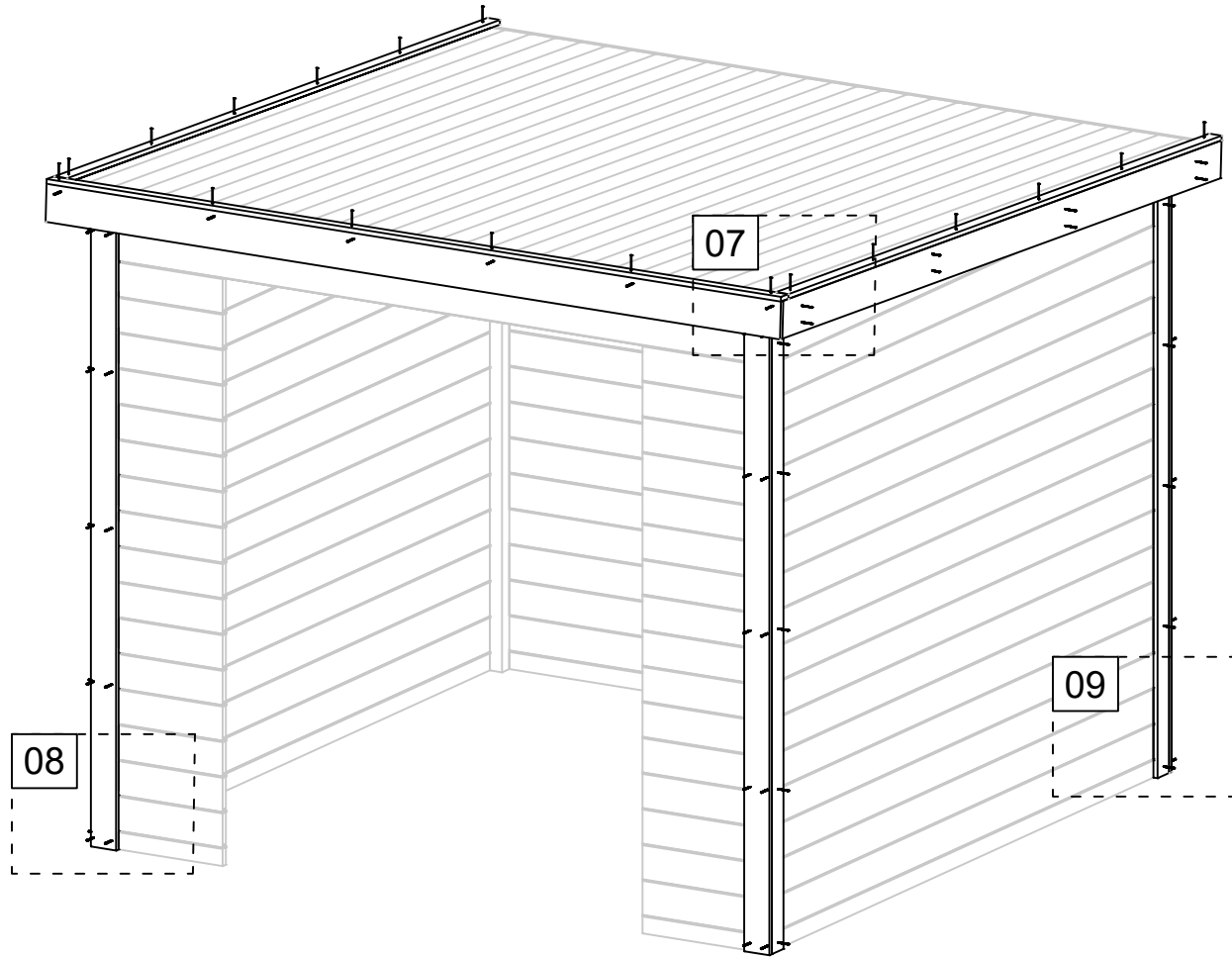

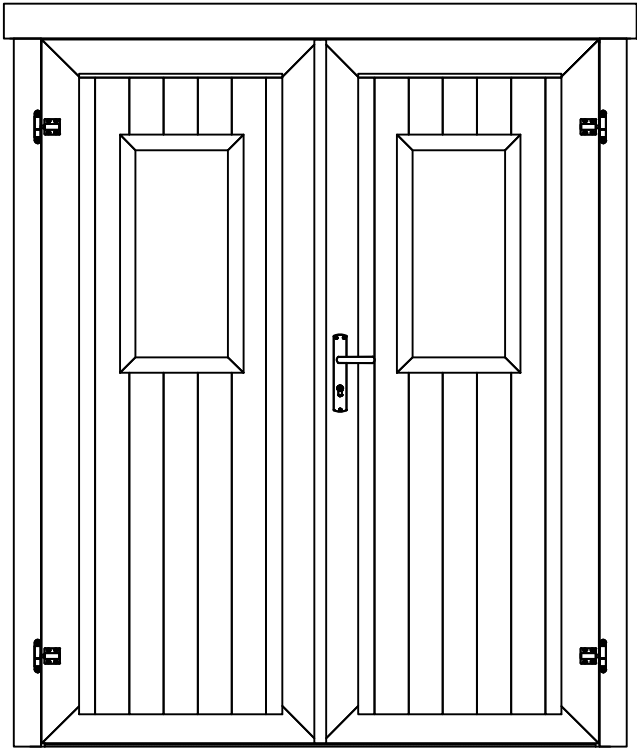
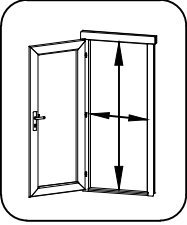

Art. Nr. 1912396



Art. Nr. 1912396



| Pos | 25.11.2025 Piece list - Stückliste - Liste des pièces - Elementi - Stuklijst - Tükítabel 1494x1850 TUK.2.010.XVP.MMX19 XGA+28 | 1/2 | Q | P (mm) | L (mm) |
|-----|---------------------------------------------------------------------------------------------------------------------------------------------------------------------------------------------|---------------------------------------------------------------------------------------|---|-----------|-----------|
| | Glass size - Glasgröße - Taille de la vitre - Misura del vetro - Glas afmeting - Klaasi mõõt: 262x549 mm | | | | |
| |   <p>1418x1794 mm</p> | | | | |
| 1 | Upper door jamb - Türrahmen oben - Cadre de porte supérieur - Telaio superiore della porta - Bovendorpel - Ukse ülemine leng |  | 1 | 66x100 | 1628 |
| 2 | Left door jamb - Türrahmen links - Cadre de porte gauche - Telaio montante sinistro della porta - Linkerstijl deurframe - Ukse vasak leng |  | 1 | 66x80 | 1850 |
| 3 | Right door jamb - Türrahmen rechts - Cadre de porte droit - Telaio montante destro della porta - Rechterstijl deurframe - Ukse parem leng |  | 1 | 66x80 | 1850 |
| 4 | Doorstep - Swelle - Barre de seuil - Soglia della porta - Deurdorpel - Lävepak |  | 1 | 18x18 | 1418 |
| 5 | Connection strip - Deckleiste - Baguette de battement - Profilo verticale della porta - Stulpelijst - kokkuvaltsiliist |  | 1 | 13x30 | 1812 |
| 6 | Window fillet - Glasleiste - Cadre de vitre - listello per finstra - Glaslijst - Klaasiliist |  | 4 | 20x40 | 318 |
| 7 | Window fillet - Glasleiste - Cadre de vitre - listello per finstra - Glaslijst - Klaasiliist |  | 4 | 20x40 | 613 |
| 8 | Window fillet - Glasleiste - Cadre de vitre - listello per finstra - Glaslijst - Klaasiliist |  | 4 | 10x40 | 318 |
| 9 | Window fillet - Glasleiste - Cadre de vitre - listello per finstra - Glaslijst - Klaasiliist |  | 4 | 10x40 | 613 |
| 10 | Glass - Glas - Vitre - Vetro - Glas - Klaas | | 2 | | |

